

Wrist Straps Grounding, Testing and Maintenance



Made in the United Kingdom

“All personnel shall be grounded or equipotentially bonded according to the requirements below [Table 2] when handling ESDs. When personnel are seated at ESD protective workstations, they shall be connected to ground via a wrist strap system.”

(EN 61340-5-1 clause 5.3.3 Personnel grounding)

Location of Wrist Strap Ground Point

Wrist straps, working surfaces and floor mats which are to be grounded for protection against electrostatic discharge (ESD) should be grounded to an Earth Bonding Point (EBP). The Earth Bonding Point should be connected to the ESD protected area (EPA) ground.

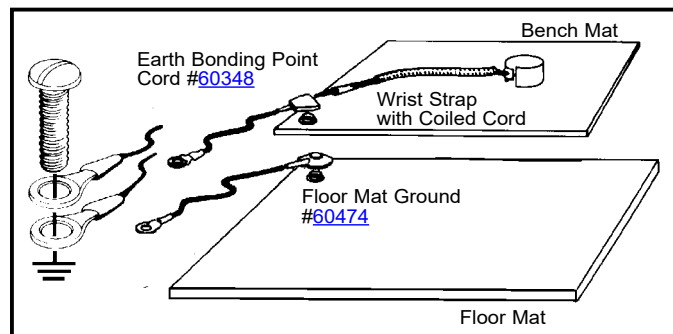

Figure 1. Earth Bonding Point for each workstation

This may be accomplished in a variety of ways utilising Earth Bonding Point plugs, ground buses or connecting directly to the nearest mains supply ground.

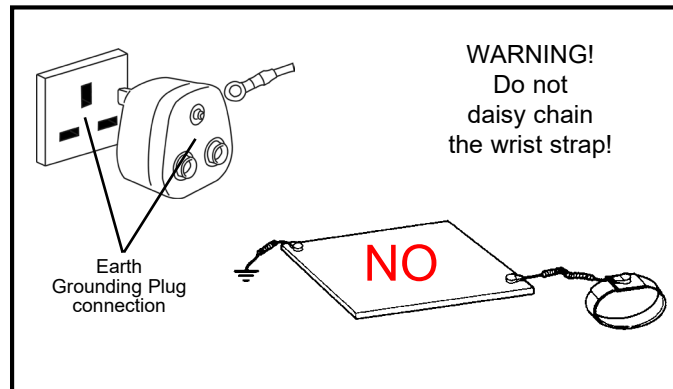

Figure 2. Equipment grounding using an EBP Plug

Each individual workstation must be individually grounded to the ground bus or to the nearest equipment ground. Do not wire work surfaces or other ESD devices in series or “daisy chain” them. This can create unknown resistance and unacceptable grounds.

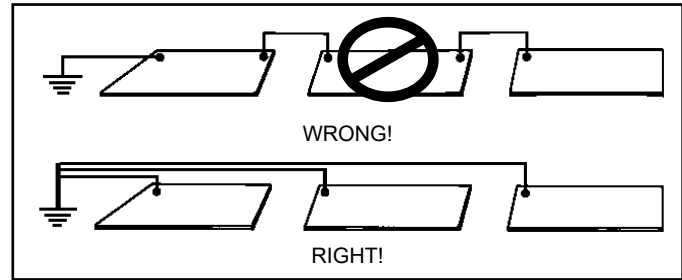

Figure 3. ESD working surfaces should never be grounded in series, i.e. daisy-chained

For instructions on grounding Desco Europe workstation mats see Technical Bulletin [TB-7505](#).

Test the Ground before you use it and periodically thereafter

You should not assume that any AC mains socket is properly wired. Even if it was originally wired correctly, it can become ungrounded due to corrosion and wear. Test the ground you intend to use before you hook up.

A Banana Jack is recommended

Almost all wrist strap manufacturers terminate wrist ground cords with banana plugs. This is because the banana plug and jack have proven to be a fast and reliable way to attach to ground. If you use another method such as snaps, be sure to test the connections often.

Note: Many wrist strap users clip the wrist cord to the edge of an ESD mat. This process is not recommended as it can increase the total system resistance to ground to over the 35 megohm required limit of EN 61340-5-1.

“Wrist strap ground cords shall be connected to a groundable point or an equipotential bonding point. Do not connect to a snap on a dissipative mat unless it is the groundable point for the mat. Do not clip a wrist strap to the edge of a dissipative mat.”

(CLC TR 61340-5-2 User guide Wrist Strap Clauses 4.7.2.6 Summary)

Best industry practice is that ESD ground connections should be firm fitting connecting devices such as metallic crimps, snaps and banana plugs shall be connected to designated ground points. The use of alligator clips is not recommended.

In some European countries, the use of ground cords with 4 mm banana plugs is not permitted. We can supply 10 mm male and female snap terminations to comply with regulations where required.

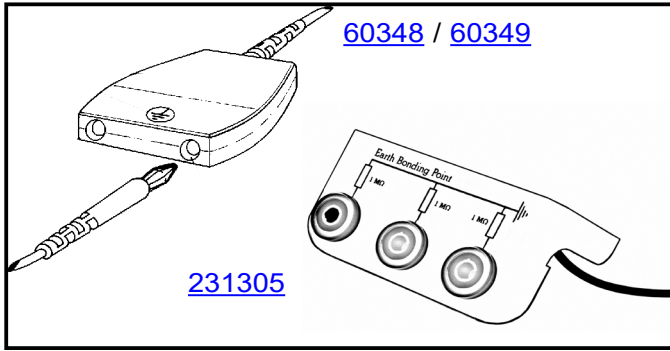

Figure 4. Desco Europe [231305](#) Earth Bonding Point Bar and [60348 / 60349](#) Earth Bonding Point Cords are two easy ways to provide multiple banana jacks at any workstation

Compliance Verification of the Ground System

Set up a schedule to be sure that all ESD grounds are inspected and tested periodically, every six months for example.

Testing the Wrist Strap

The best test of the wrist strap system is while it is worn. This includes all three components: the wristband, the ground cord (including resistor), and the interface with the wearer's skin.

“Because wrist straps have a finite life, it is important to develop a test frequency that will guarantee integrity of the system. Typical test programs recommend that wrist straps that are used daily should be tested daily. However, if the products that are being produced are of such value that a guarantee of a continuous, reliable ground is needed then continuous monitoring should be considered or even required.” (CLC TR 61340-5-2 User guide Wrist Strap Clauses 4.7.4.4 Test frequency)



Figure 5. Wrist strap testers and continuous monitors

Desco Europe has several testers available for this purpose. Power cords must be ordered separately. For more information click [here](#).

If you obtain an open or bad reading from the tester you should stop work and test the wristband and cord individually to find out which item has failed. Replace the bad component and test the system again. Obtain a “Pass” reading before beginning work.

DESCO EUROPE - 2A DUNHAMS LANE, LETCHWORTH, HERTFORDSHIRE, SG6 1BE, UK
Phone: +44 (0) 1462 672005 • E-mail: Service@DescoEurope.com, Website: DescoEurope.com

Desco Europe has several continuous monitors available if a reliable ground connection is required. For more information click [here](#).

“Compliance verification records shall be established and maintained to provide evidence of conformity to the technical requirements.”

(EN 61340-5-1 clause 5.2.4 Compliance verification plan)

Cleaning

For proper operation, the wrist strap, especially the wristband strip, must be kept clean. All wristbands should be cleaned with a mild detergent on a periodic basis. Be sure that metallic expansion wristbands are thoroughly dried to prevent corrosion.

Woolite™ works well. Liquid detergents are better than dry in that there is less caking and frictional wear. Launder elastic wristband strips in cool or warm water, tumble dry with low heat or hang dry. DO NOT BLEACH.

Wrist Strap silver fibres are sensitive to heat and should not be exposed to laundering heat in excess of 50 °C. Use only non-ionic softeners and detergents when laundering.

Size Adjustment of Wristbands

Elastic adjustable Wristbands with Opening Clasp

1. Place the wristband on the wrist.
2. Open the clasp by pulling upward on the “tail” of material that extends out from the clasp.
3. Tighten or loosen the elastic material through the clasp until the wristband fits snugly but comfortably.
4. We recommend that you close the clasp and wear the band with the excess tail extended for a day to be sure the adjustment is snug, comfortable and has the proper electrical contact with the skin before cutting.

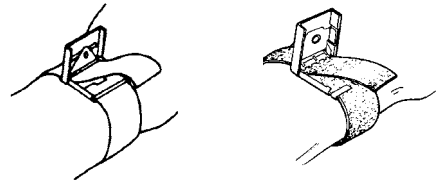

5. Test the wrist strap system to be sure of proper electrical resistance and skin contact. Use the procedure described under “Testing the Wrist Strap”.
6. When you are ready to cut off excess material, mark with a pencil where excess material is to be trimmed.

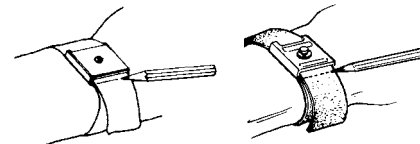

7. Remove band from wrist. Open clasp. Cut off excess material about 6 mm short of pencil mark so that the end of material is concealed by the cap. This will eliminate the possibility of exposed frayed ends.

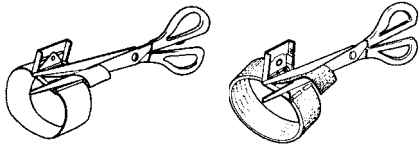

8. Close clasp and use as a fixed elastic wristband.

Elastic Adjustable Wristbands without Opening Clasp

The elastic adjustable band is designed to be adjusted to the proper size to fit each individual wearer. After adjustment, it can be used as a fixed size band.

1. Hold the wristband by the buckle.
2. Pull the "tail" of material that extends out from the buckle to tighten the elastic material until the wristband fits snugly but comfortably.
3. To loosen the elastic material, hold it on both sides of

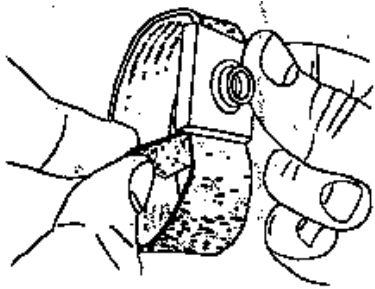

the buckle and pull in opposite directions so that the material "tail" gets shorter.

4. Using the equipment shown in Figure 5 under "Testing the Wrist Strap", test the wristband while it is worn to be sure of proper electrical resistance.

Metal Expansion Wristbands

1. Insert the link end of the wristband into the slotted opening on the cap. Insert it at a downward angle to allow the links to slide inside the channel in the backplate.

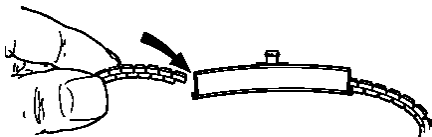

2. Change the size of the band by sliding the links in or out of the stainless steel backplate. For extra small you can cut off excess links with cutters.
3. Lock the links into place by pulling down on the band,

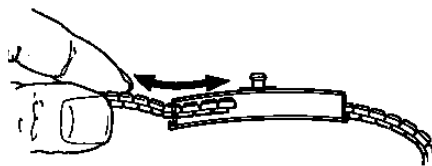

seating the band securely over the lip on the edge of the backplate.

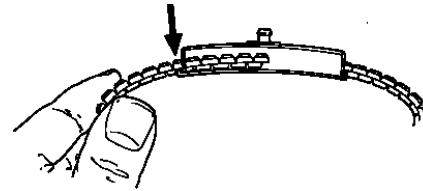

4. Test the wrist strap system to be sure of proper electrical resistance and skin contact. Use the procedure described under "Testing the Wrist Strap".

NOTE: Wrist straps are not recommended for use on equipment with operating voltages exceeding 250 VAC. CAUTION: The ESD series is for electrostatic control. It will not reduce or increase your risk of receiving electric shock when using or working on electrical equipment. Follow the same precautions you would use without wrist straps, including:

- Make certain that equipment having a grounding type plug is properly grounded.
- Make certain that you are not in contact with grounded objects other than through the ESD series.

Limited Warranty, Warranty Exclusions, Limit of Liability and RMA Request Instructions

See the Desco Europe Warranty -

DescoEurope.com/Limited-Warranty.aspx